

# Grande Max



Made in Italy, GRANDE MAX features the classical elegance of numerous types of marble, stone, metal and concrete translated into stoneware with satin and polished surfaces. GRANDE MAX is available in 6mm and 12mm thickness. The 6mm is ideal for both horizontal and vertical flat surfaces including facades for both indoor and outdoor and the 12mm ideal for bench tops, cladding and furniture.

**PRODUCT TYPE:** 6mm and 12mm porcelain slabs

**MARBLE LIGHT:** Golden White, Calacatta Extra, Statuario Altissimo and Capraia

**MARBLE DARK:** Elegant Black, Imperiale, Pulpis and St Laurent

**STONE:** Brera Grey, Ceppo Di Gre, Basaltina and Bluestone

**CONCRETE:** Concrete Smoke and Concrete White

**SOLID:** Solid White and Solid Black,

**METAL:** Metal Iron Dark and Metal Iron Light

**SIZES:** 1200x1200x6mm, 1200x2400x6mm, 1200x2780x6mm, 1600x3200x6mm and 1620x3240x12mm Rectified

**FINISHES/USAGE:** Satin, Polish, Matt, Extra Polish and Extra Satin/Wall and Floor

**AESTHETIC QUALITIES:** Stone and Marble look porcelain slabs

**ORIGIN:** Italy

**TECHNICAL DATA:** More technical data on the last page

# Grande Max

## PRODUCT SPECIFICATIONS

SIZES	FINISHES	TILE EDGE
1200x1200x6mm*	SATIN	RECTIFIED
1200x2400x6mm*	SATIN	RECTIFIED
1200x2780x6mm*	SATIN	RECTIFIED
1600x3200x6mm	SATIN	RECTIFIED
1200x1200x6mm*	POLISH	RECTIFIED
1200x2400x6mm*	POLISH	RECTIFIED
1200x2780x6mm*	POLISH	RECTIFIED
1600x3200x6mm	POLISH	RECTIFIED
1620x3240x12mm	SATIN	-
1620x3240x12mm*	POLISH	-

\* Indent item - Subject to stock availability overseas, please allow 10-12 weeks lead time from date of order confirmation. Minimum quantity may apply.

## FORMATS

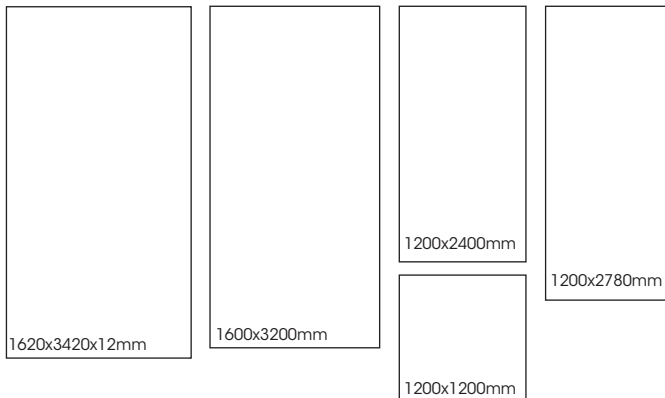

GOLDEN WHITE

# Grande Max

## GOLDEN WHITE SLAB VARIATION

1620x3420x12mm



1600x3200x6mm



1200x2400x6mm



1200x1200x6mm



# Grande Max

## PRODUCT SPECIFICATIONS

SIZES	FINISHES	TILE EDGE
1200x1200x6mm*	SATIN	RECTIFIED
1200x2400x6mm*	SATIN	RECTIFIED
1600x3200x6mm	SATIN	RECTIFIED
1200x1200x6mm*	POLISH	RECTIFIED
1200x2400x6mm*	POLISH	RECTIFIED
1600x3200x6mm*	POLISH	RECTIFIED
1620x3240x12mm	EXTRA SATIN	-
1620x3240x12mm	EXTRA POLISH	-

\* Indent item - Subject to stock availability overseas, please allow 10-12 weeks lead time from date of order confirmation. Minimum quantity may apply.

## FORMATS

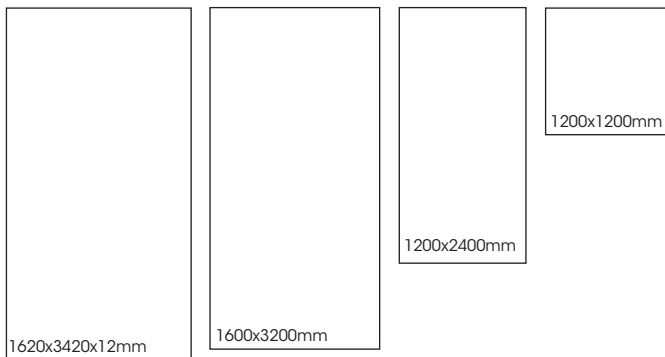

CALACATTA EXTRA

# Grande Max

## CALACATTA EXTRA SLAB VARIATION

1620x3420x12mm



1600x3200x6mm



1200x2400x6mm



1200x1200x6mm

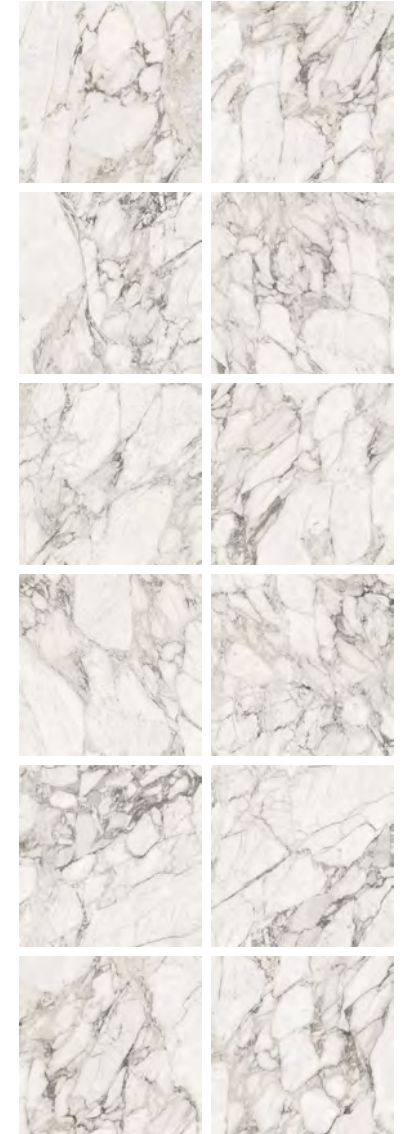

# Grande Max

## PRODUCT SPECIFICATIONS

SIZES	FINISHES	TILE EDGE
1200x1200x6mm*	SATIN	RECTIFIED
1200x2400x6mm*	SATIN	RECTIFIED
1200x2780x6mm*	SATIN	RECTIFIED
1600x3200x6mm	SATIN	RECTIFIED
1200x1200x6mm*	POLISH	RECTIFIED
1200x2400x6mm*	POLISH	RECTIFIED
1200x2780x6mm*	POLISH	RECTIFIED
1600x3200x6mm	POLISH	RECTIFIED
1620x3240x12mm	SATIN	-
1620x3240x12mm	POLISH	-

\* Indent item - Subject to stock availability overseas, please allow 10-12 weeks lead time from date of order confirmation. Minimum quantity may apply.

## FORMATS

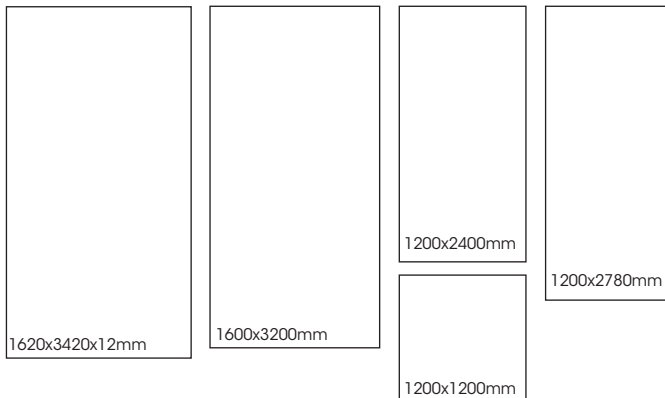

STATUARIO

# Grande Max

## STATUARIO SLAB VARIATION

1620x3420x12mm



1600x3200x6mm



1200x2400x6mm

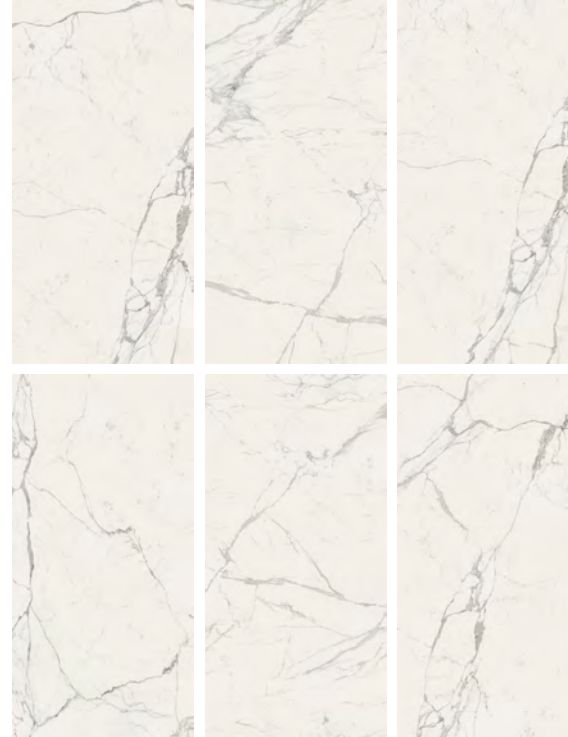

1200x1200x6mm

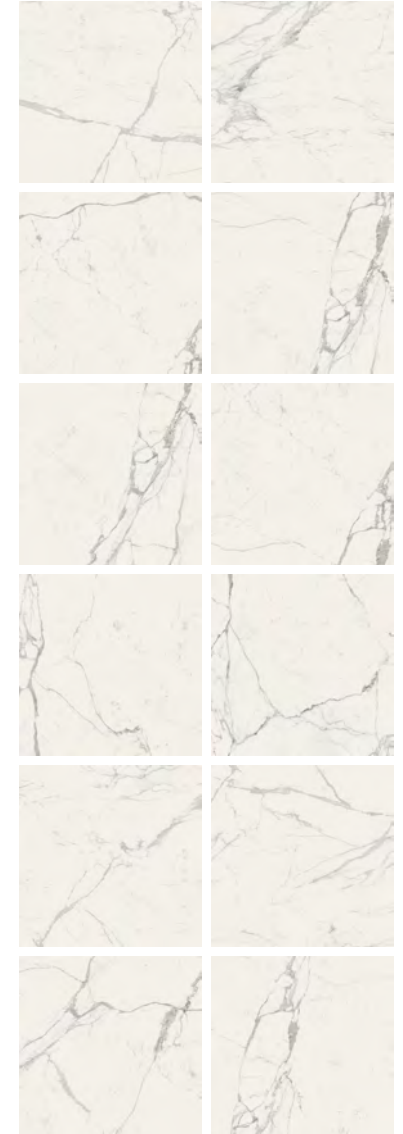

# Grande Max

## STATUARIO BOOKMATCH SLAB VARIATION

1600x3200x6mm

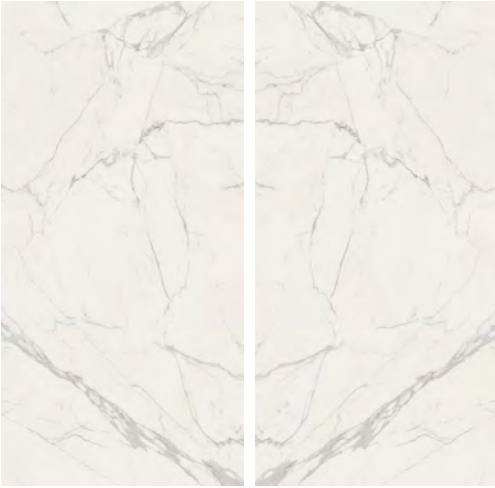

1200x2400x6mm

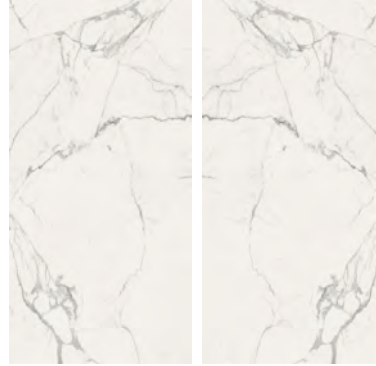



# Grande Max

## PRODUCT SPECIFICATIONS

SIZES	FINISHES	TILE EDGE
1200x1200x6mm*	SATIN	RECTIFIED
1200x2400x6mm*	SATIN	RECTIFIED
1200x2780x6mm*	SATIN	RECTIFIED
1600x3200x6mm	SATIN	RECTIFIED
1200x1200x6mm*	POLISH	RECTIFIED
1200x2400x6mm*	POLISH	RECTIFIED
1200x2780x6mm*	POLISH	RECTIFIED
1600x3200x6mm	POLISH	RECTIFIED
1620x3240x12mm	SATIN	-
1620x3240x12mm	POLISH	-

\* Indent item - Subject to stock availability overseas, please allow 10-12 weeks lead time from date of order confirmation. Minimum quantity may apply.

## FORMATS

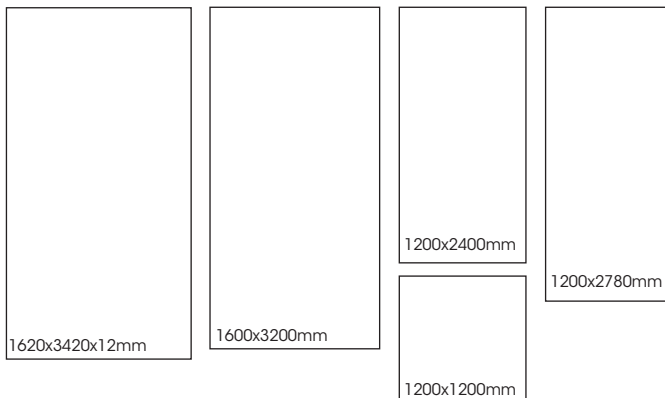

ALTISSIMO

# Grande Max

## ALTISSIMO SLAB VARIATION

1620x3420x12mm



1600x3200x6mm



1200x2400x6mm



1200x1200x6mm



# Grande Max

## PRODUCT SPECIFICATIONS

SIZES	FINISHES	TILE EDGE
1200x1200x6mm*	SATIN	RECTIFIED
1200x2400x6mm*	SATIN	RECTIFIED
1200x1200x6mm*	POLISH	RECTIFIED
1200x2400x6mm*	POLISH	RECTIFIED
1600x3200x6mm*	POLISH	RECTIFIED
1620x3240x12mm	POLISH	-

\* Indent item - Subject to stock availability overseas, please allow 10-12 weeks lead time from date of order confirmation. Minimum quantity may apply.

## FORMATS

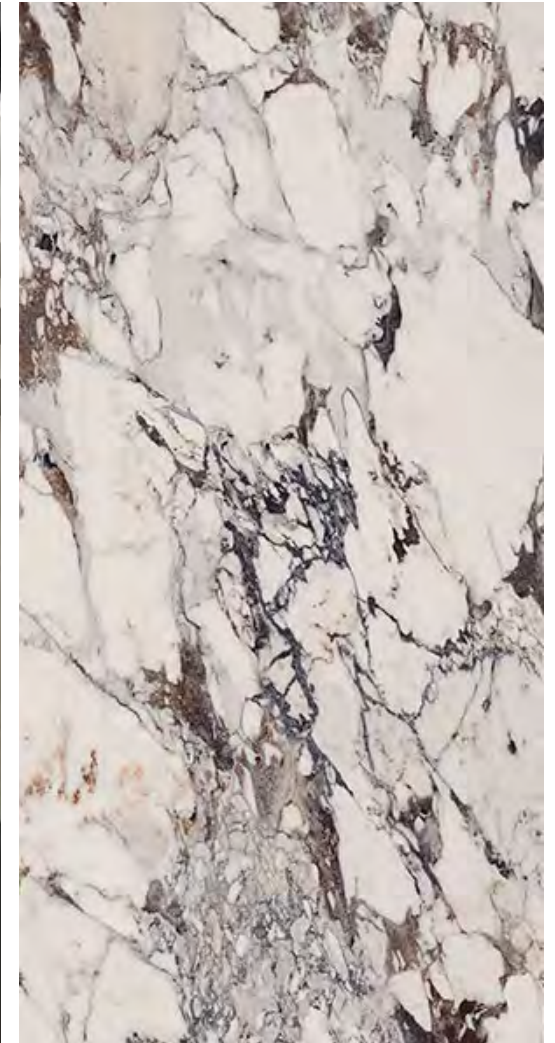
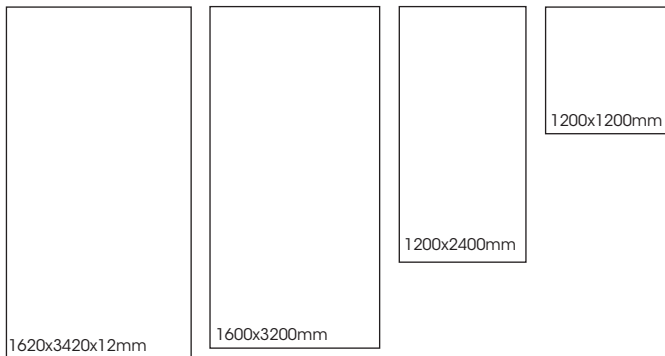

CAPRAIA

# Grande Max

## CAPRAIA SLAB VARIATION

1620x3420x12mm



1600x3200x6mm

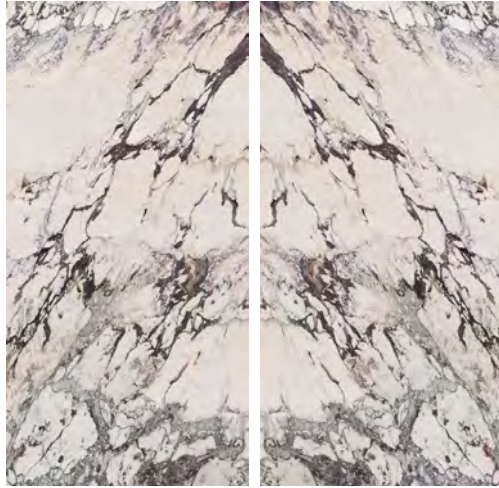

1200x2400x6mm



1200x1200x6mm

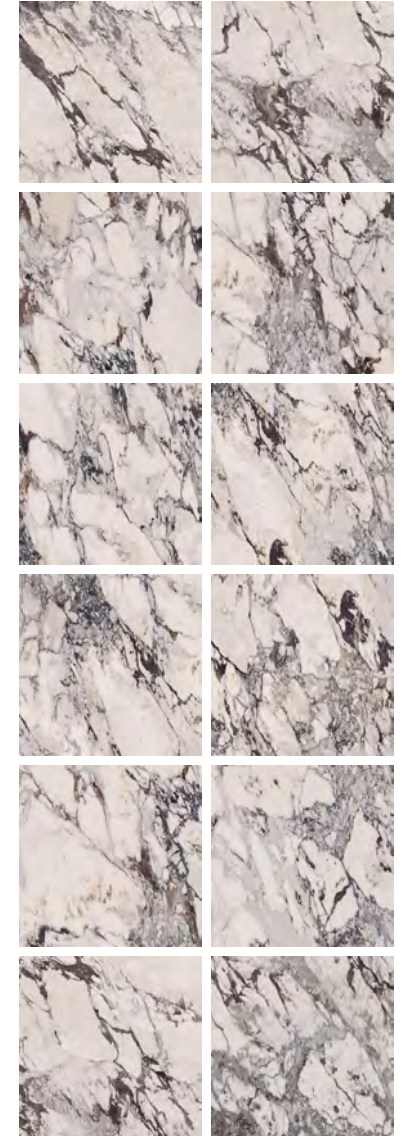

# Grande Max

## PRODUCT SPECIFICATIONS

SIZES	FINISHES	TILE EDGE
1200x1200x6mm*	SATIN	RECTIFIED
1200x2400x6mm*	SATIN	RECTIFIED
1200x2780x6mm*	SATIN	RECTIFIED
1600x3200x6mm	SATIN	RECTIFIED
1200x1200x6mm*	POLISH	RECTIFIED
1200x2400x6mm*	POLISH	RECTIFIED
1200x2780x6mm*	POLISH	RECTIFIED
1600x3200x6mm	POLISH	RECTIFIED
1620x3240x12mm	SATIN	-
1620x3240x12mm*	POLISH	-

\* Indent item - Subject to stock availability overseas, please allow 10-12 weeks lead time from date of order confirmation. Minimum quantity may apply.

## FORMATS

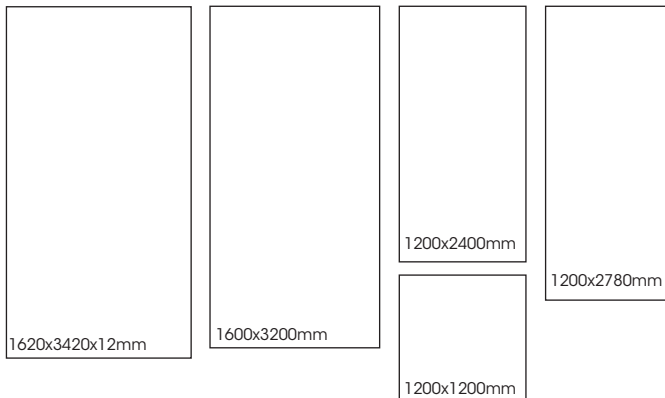

ELEGANT BLACK

# Grande Max

## ELEGANT BLACK SLAB VARIATION

1620x3420x12mm



1600x3200x6mm



1200x2400x6mm

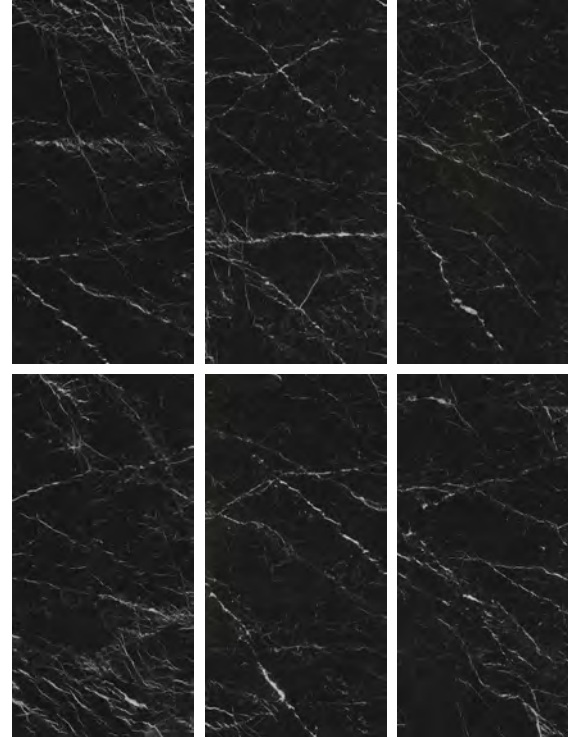

1200x1200x6mm

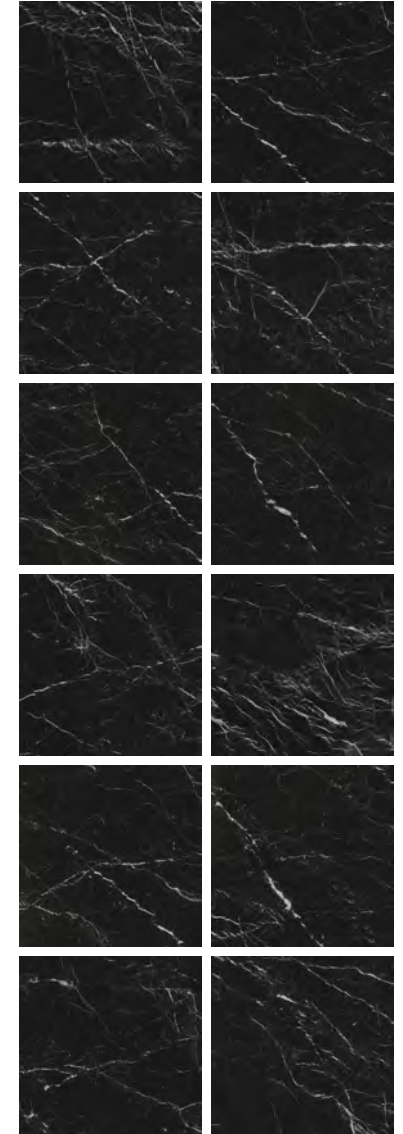

# Grande Max

## PRODUCT SPECIFICATIONS

SIZES	FINISHES	TILE EDGE
1200x1200x6mm*	SATIN	RECTIFIED
1200x2400x6mm*	SATIN	RECTIFIED
1200x1200x6mm*	POLISH	RECTIFIED
1200x2400x6mm*	POLISH	RECTIFIED
1600x3200x6mm*	POLISH	RECTIFIED
1620x3240x12mm	SATIN	-
1620x3240x12mm*	POLISH	-

\* Indent item - Subject to stock availability overseas, please allow 10-12 weeks lead time from date of order confirmation. Minimum quantity may apply.

## FORMATS

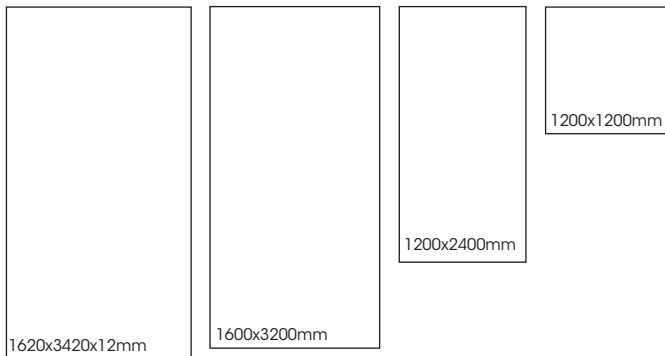

IMPERIALE

# Grande Max

## IMPERIALE SLAB VARIATION

1620x3420x12mm



1600x3200x6mm



1200x2400x6mm

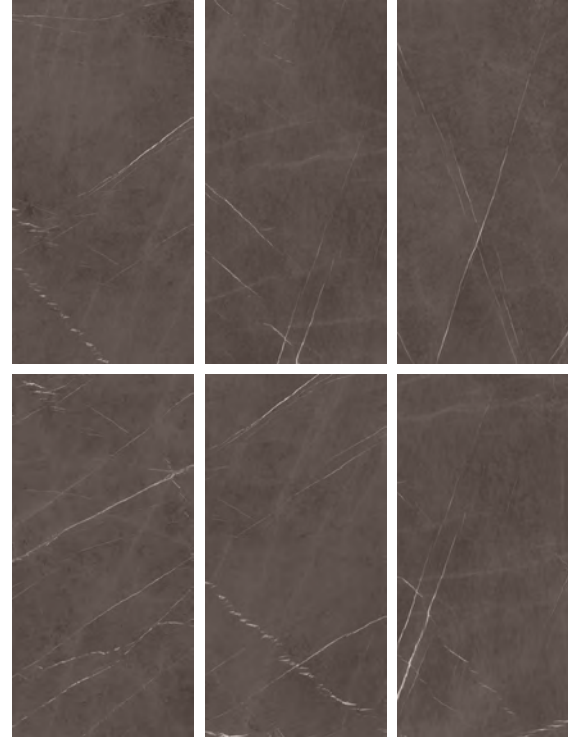

1200x1200x6mm





# Grande Max

## PRODUCT SPECIFICATIONS

SIZES	FINISHES	TILE EDGE
1200x1200x6mm*	SATIN	RECTIFIED
1200x2400x6mm*	SATIN	RECTIFIED
1200x1200x6mm*	POLISH	RECTIFIED
1200x2400x6mm*	POLISH	RECTIFIED
1600x3200x6mm*	POLISH	RECTIFIED
1620x3240x12mm*	SATIN	-
1620x3240x12mm*	POLISH	-

\* Indent item - Subject to stock availability overseas, please allow 10-12 weeks lead time from date of order confirmation. Minimum quantity may apply.

## FORMATS

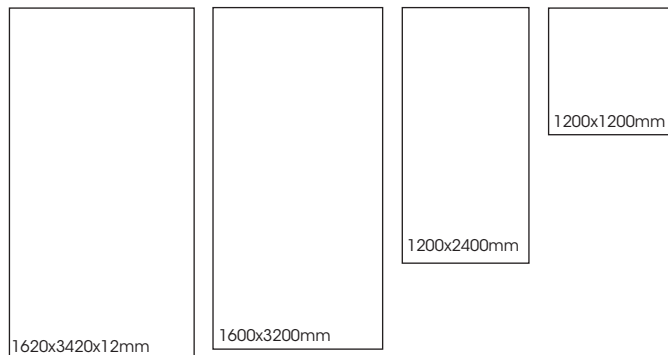

PULPIS

# Grande Max

## PULPIS SLAB VARIATION

1620x3420x12mm



1600x3200x6mm

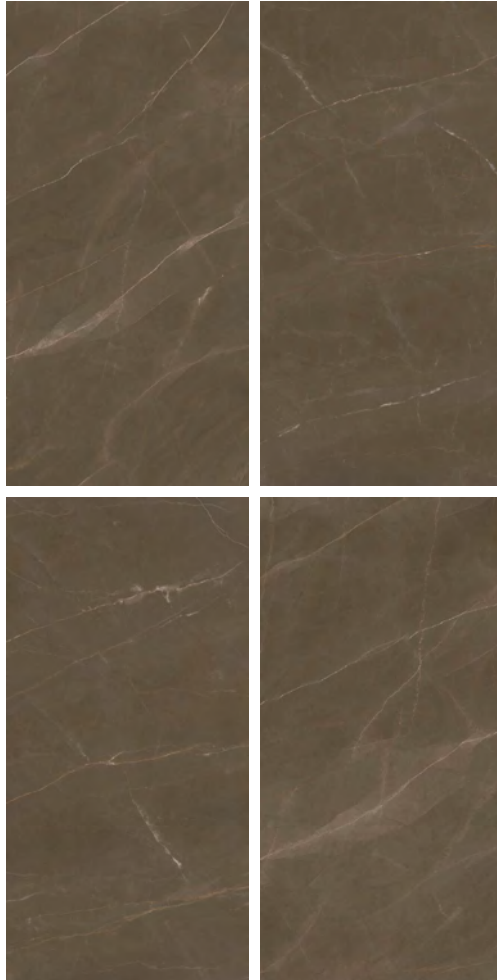

1200x2400x6mm

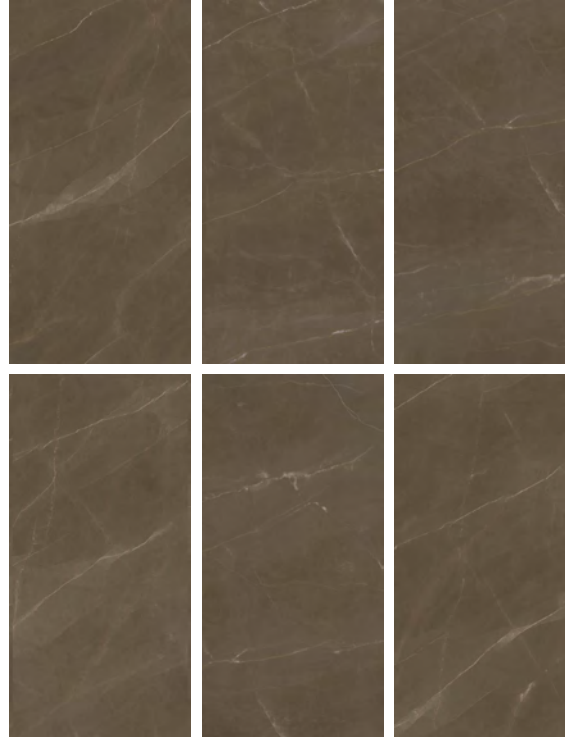

1200x1200x6mm



# Grande Max

## PRODUCT SPECIFICATIONS

SIZES	FINISHES	TILE EDGE
1200x1200x6mm*	SATIN	RECTIFIED
1200x2400x6mm*	SATIN	RECTIFIED
1200x2780x6mm*	SATIN	RECTIFIED
1600x3200x6mm*	SATIN	RECTIFIED
1200x1200x6mm*	POLISH	RECTIFIED
1200x2400x6mm*	POLISH	RECTIFIED
1200x2780x6mm*	POLISH	RECTIFIED
1600x3200x6mm*	POLISH	RECTIFIED
1620x3240x12mm*	SATIN	-
1620x3240x12mm*	POLISH	-

\* Indent item - Subject to stock availability overseas, please allow 10-12 weeks lead time from date of order confirmation. Minimum quantity may apply.

## FORMATS

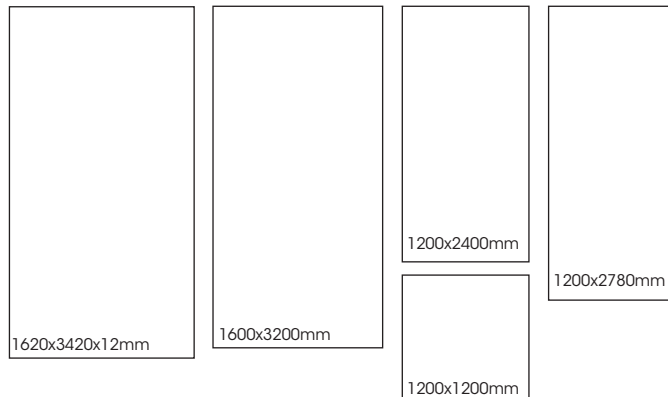

ST LAURENT

# Grande Max

## ST LAURENT SLAB VARIATION

1620x3420x12mm

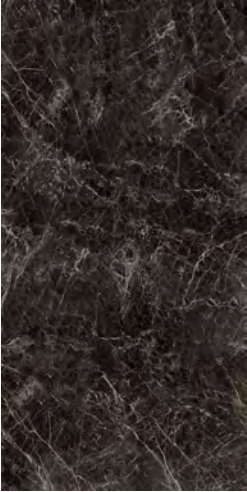

1600x3200x6mm

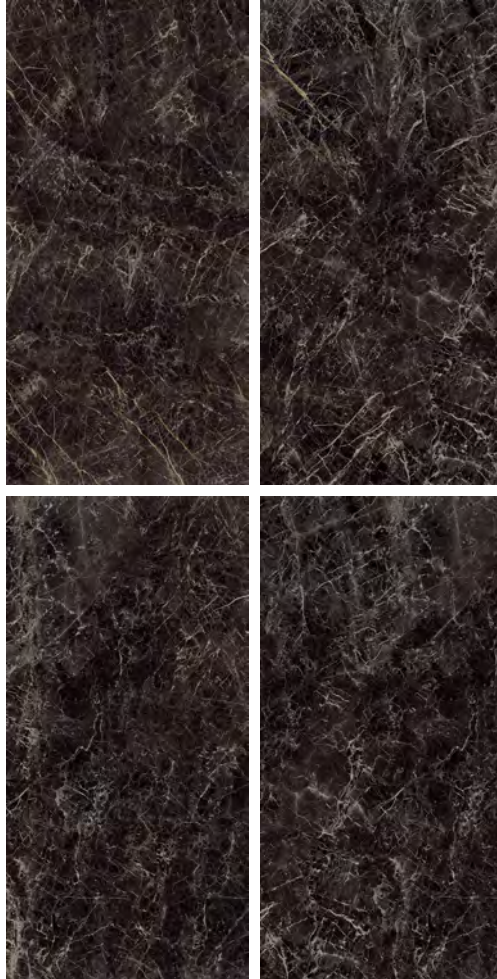

1200x2400x6mm



1200x1200x6mm



# Grande Max

## PRODUCT SPECIFICATIONS

SIZES	FINISHES	TILE EDGE
1200x1200x6mm*	SATIN	RECTIFIED
1200x2400x6mm*	SATIN	RECTIFIED
1600x3200x6mm	SATIN	RECTIFIED
1200x1200x6mm*	POLISH	RECTIFIED
1200x2400x6mm*	POLISH	RECTIFIED
1600x3200x6mm*	POLISH	RECTIFIED
1620x3240x12mm*	SATIN	-
1620x3240x12mm*	POLISH	-

\* Indent item - Subject to stock availability overseas, please allow 10-12 weeks lead time from date of order confirmation. Minimum quantity may apply.

## FORMATS

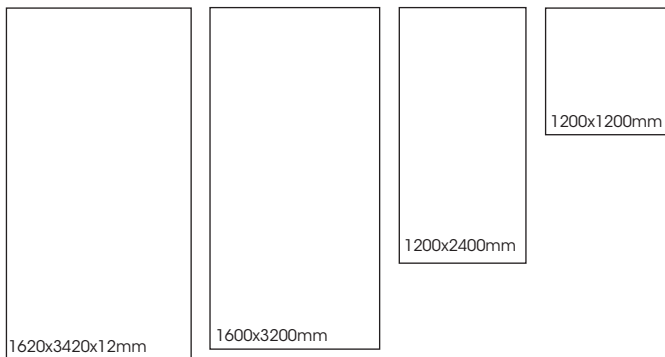

BRERA GREY

# Grande Max

## BRERA GREY SLAB VARIATION

1620x3420x12mm



1600x3200x6mm



1200x2400x6mm

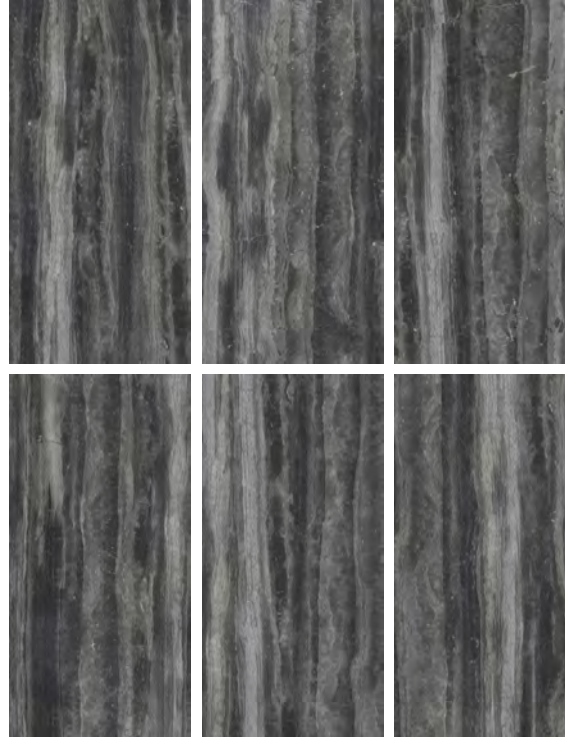

1200x1200x6mm

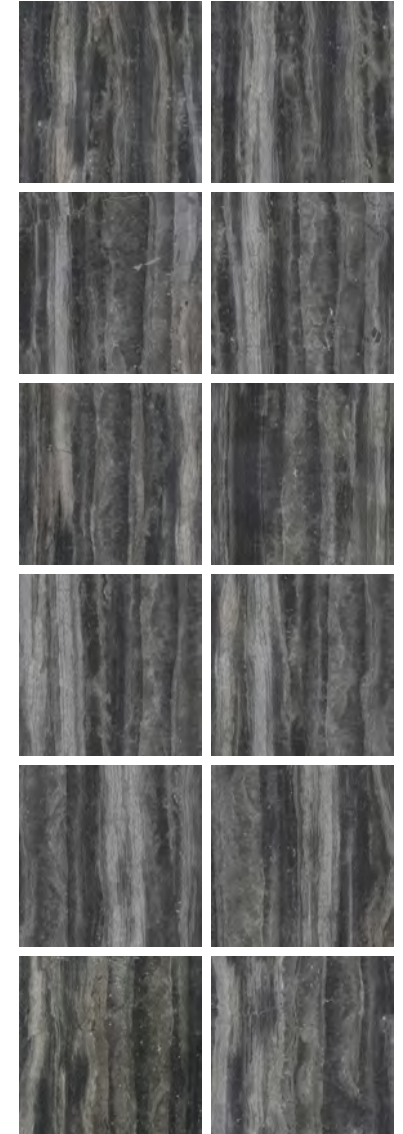

# Grande Max

## PRODUCT SPECIFICATIONS

SIZES	FINISHES	TILE EDGE
1200x1200x6mm*	MATT	RECTIFIED
1200x2400x6mm*	MATT	RECTIFIED
1600x3200x6mm*	MATT	RECTIFIED
1620x3240x12mm	MATT	-

\* Indent item - Subject to stock availability overseas, please allow 10-12 weeks lead time from date of order confirmation. Minimum quantity may apply.

## FORMATS

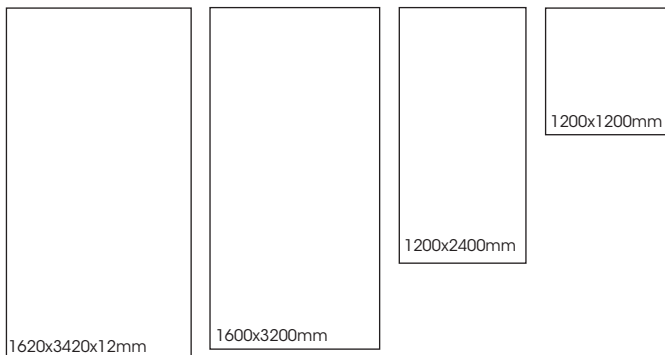

CEPPO DI GRE

# Grande Max

## CEPPO DI GRE SLAB VARIATION

1620x3420x12mm



1600x3200x6mm



1200x2400x6mm



1200x1200x6mm





# Grande Max

## PRODUCT SPECIFICATIONS

SIZES	FINISHES	TILE EDGE
1620x3240x12mm	MATT	-

\* Indent item - Subject to stock availability overseas, please allow 10-12 weeks lead time from date of order confirmation. Minimum quantity may apply.

## FORMATS

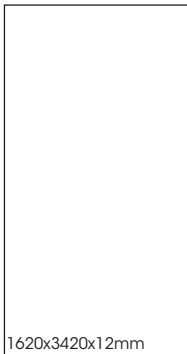

BASALTINA

# Grande Max

## PRODUCT SPECIFICATIONS

SIZES	FINISHES	TILE EDGE
1620x3240x12mm	MATT	-

\* Indent item - Subject to stock availability overseas, please allow 10-12 weeks lead time from date of order confirmation. Minimum quantity may apply.

## FORMATS

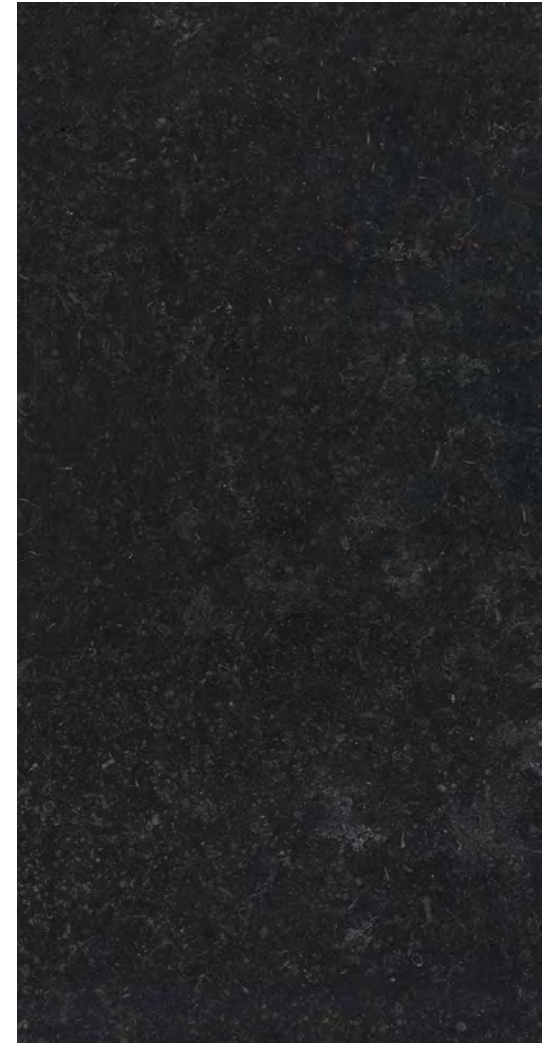
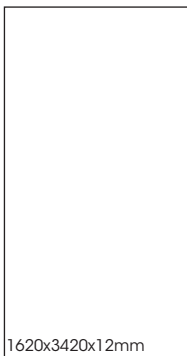

BLUESTONE

# Grande Max

## PRODUCT SPECIFICATIONS

SIZES	FINISHES	TILE EDGE
1200x1200x6mm*	MATT	RECTIFIED
1200x2400x6mm*	MATT	RECTIFIED
1600x3200x6mm*	MATT	RECTIFIED
1620x3240x12mm	MATT	-

\* Indent item - Subject to stock availability overseas, please allow 10-12 weeks lead time from date of order confirmation. Minimum quantity may apply.

## FORMATS

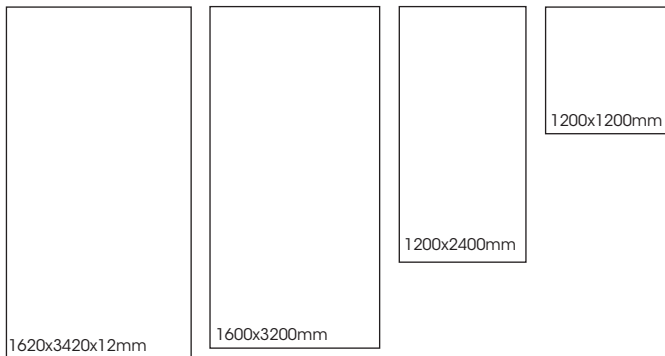

CONCRETE SMOKE

# Grande Max

## CONCRETE SMOKE SLAB VARIATION

1620x3420x12mm

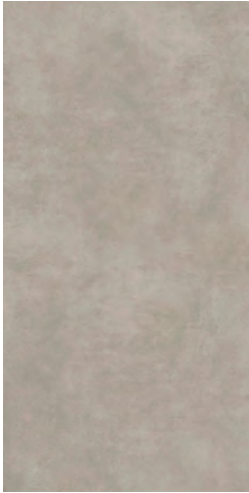

1600x3200x6mm

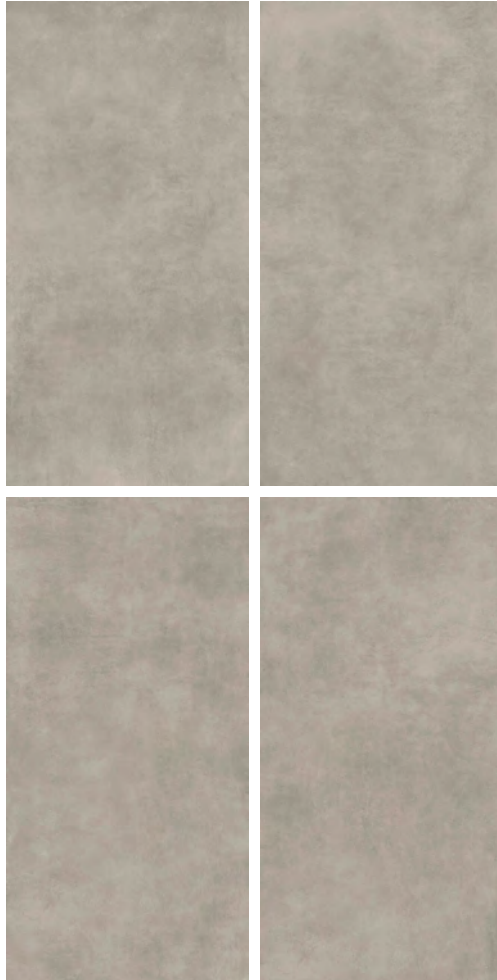

1200x2400x6mm

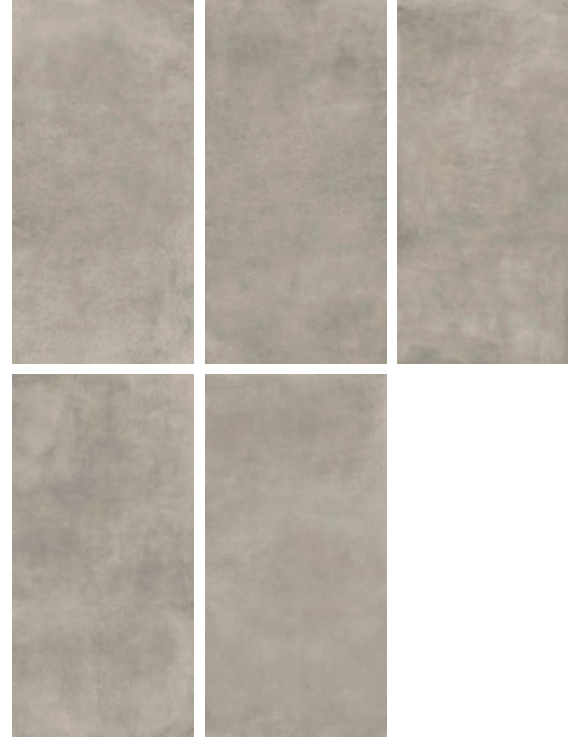

1200x1200x6mm

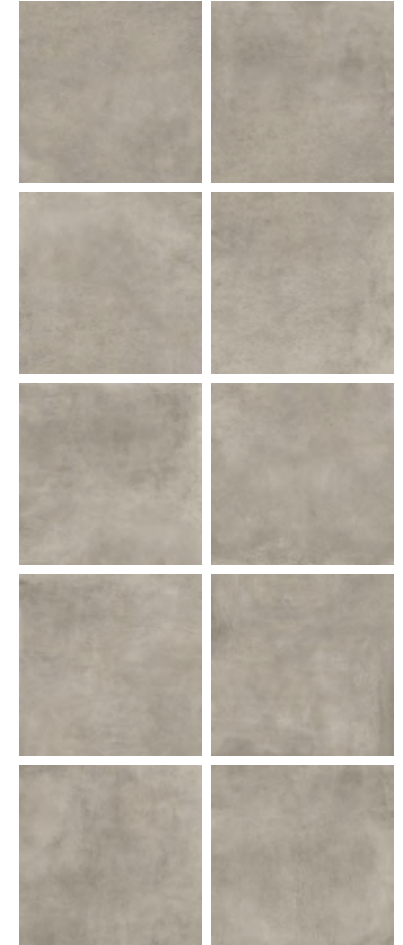

# Grande Max

## PRODUCT SPECIFICATIONS

SIZES	FINISHES	TILE EDGE
1200x1200x6mm*	MATT	RECTIFIED
1200x2400x6mm*	MATT	RECTIFIED
1600x3200x6mm*	MATT	RECTIFIED
1620x3240x12mm	MATT	-

\* Indent item - Subject to stock availability overseas, please allow 10-12 weeks lead time from date of order confirmation. Minimum quantity may apply.

## FORMATS

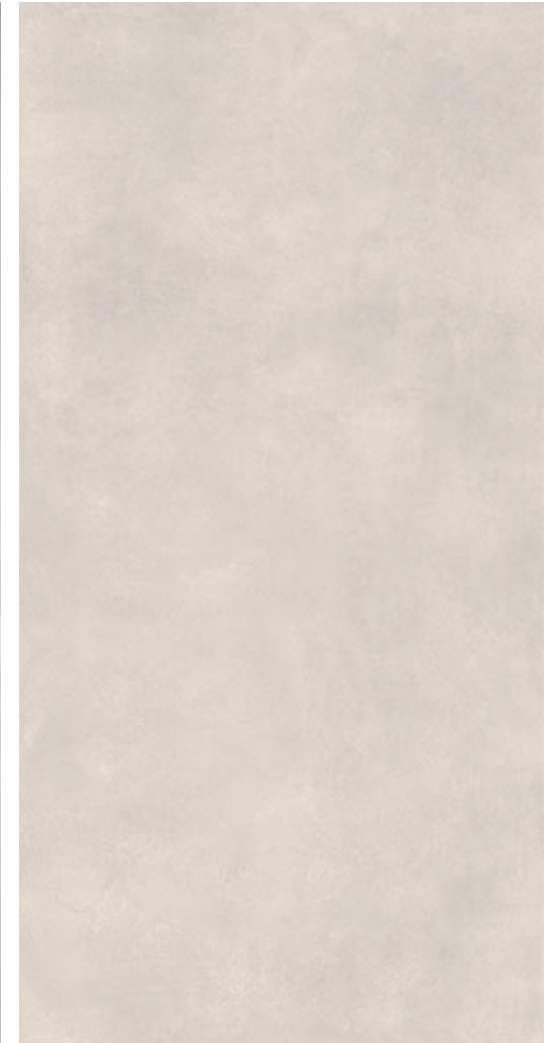
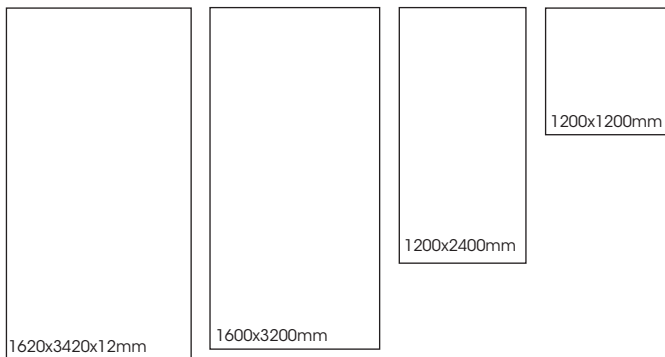

CONCRETE WHITE

# Grande Max

## CONCRETE WHITE SLAB VARIATION

1620x3420x12mm



1600x3200x6mm

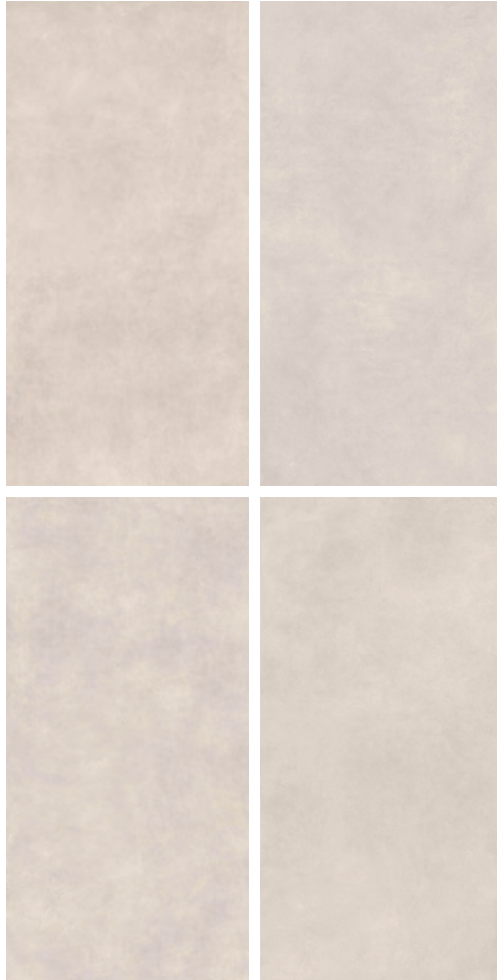

1200x2400x6mm

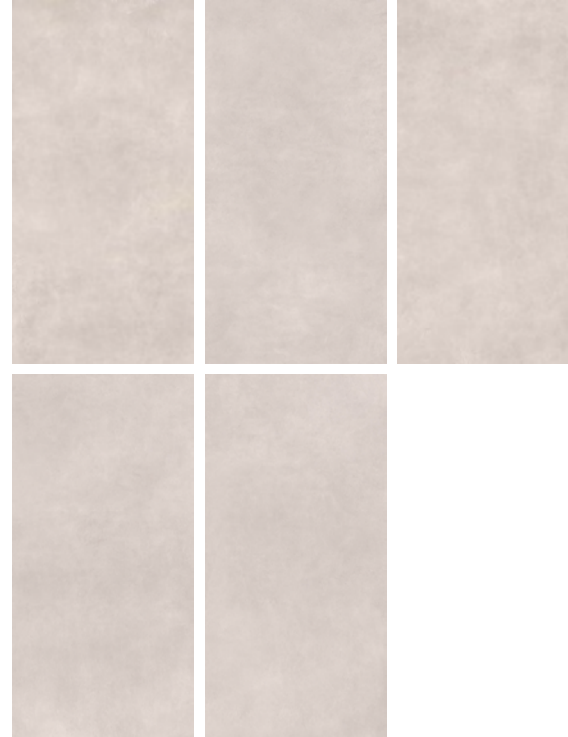

1200x1200x6mm

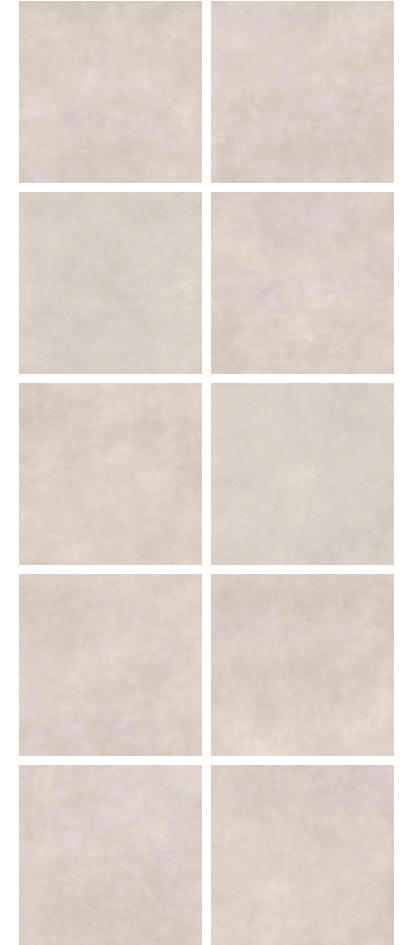

# Grande Max

## PRODUCT SPECIFICATIONS

SIZES	FINISHES	TILE EDGE
1600x3200x6mm*	POLISH	RECTIFIED
1600x3200x6mm*	SATIN	RECTIFIED
1620x3240x12mm*	POLISH	-
1620x3240x12mm	SATIN	-

\* Indent item - Subject to stock availability overseas, please allow 10-12 weeks lead time from date of order confirmation. Minimum quantity may apply.

## FORMATS

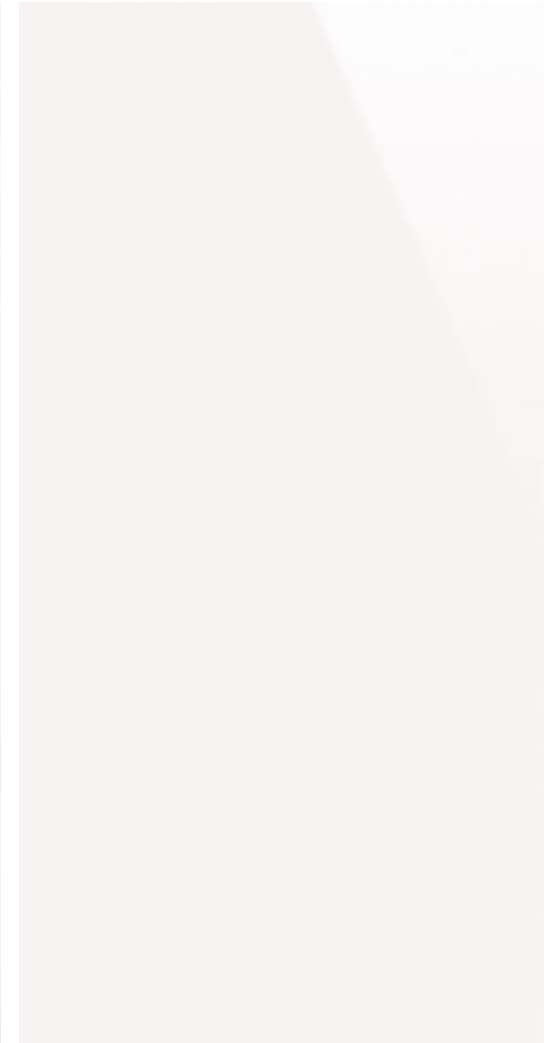
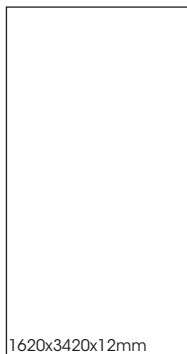

SOLID WHITE

# Grande Max

## PRODUCT SPECIFICATIONS

SIZES	FINISHES	TILE EDGE
1620x3240x12mm	SATIN	-

\* Indent item - Subject to stock availability overseas, please allow 10-12 weeks lead time from date of order confirmation. Minimum quantity may apply.

## FORMATS

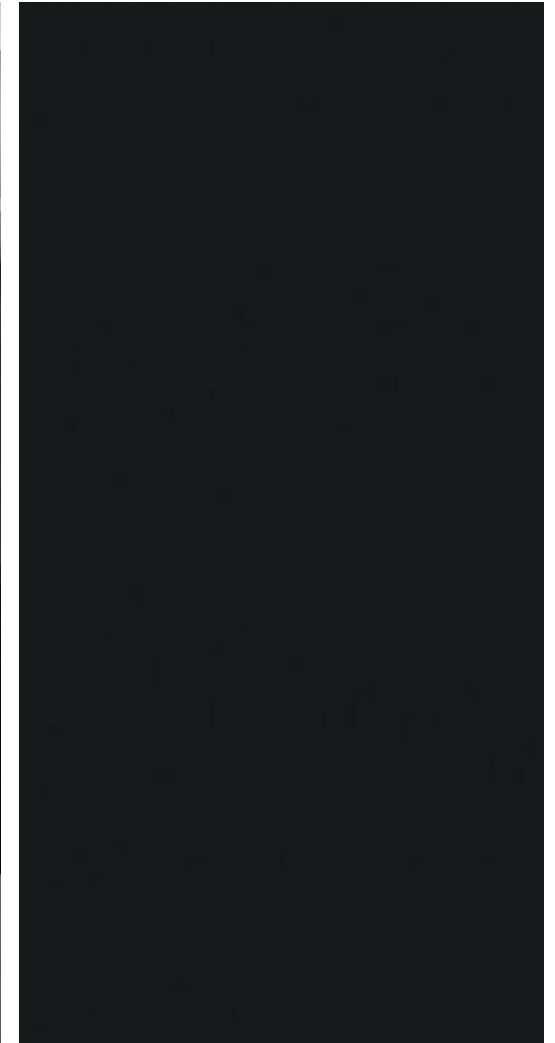
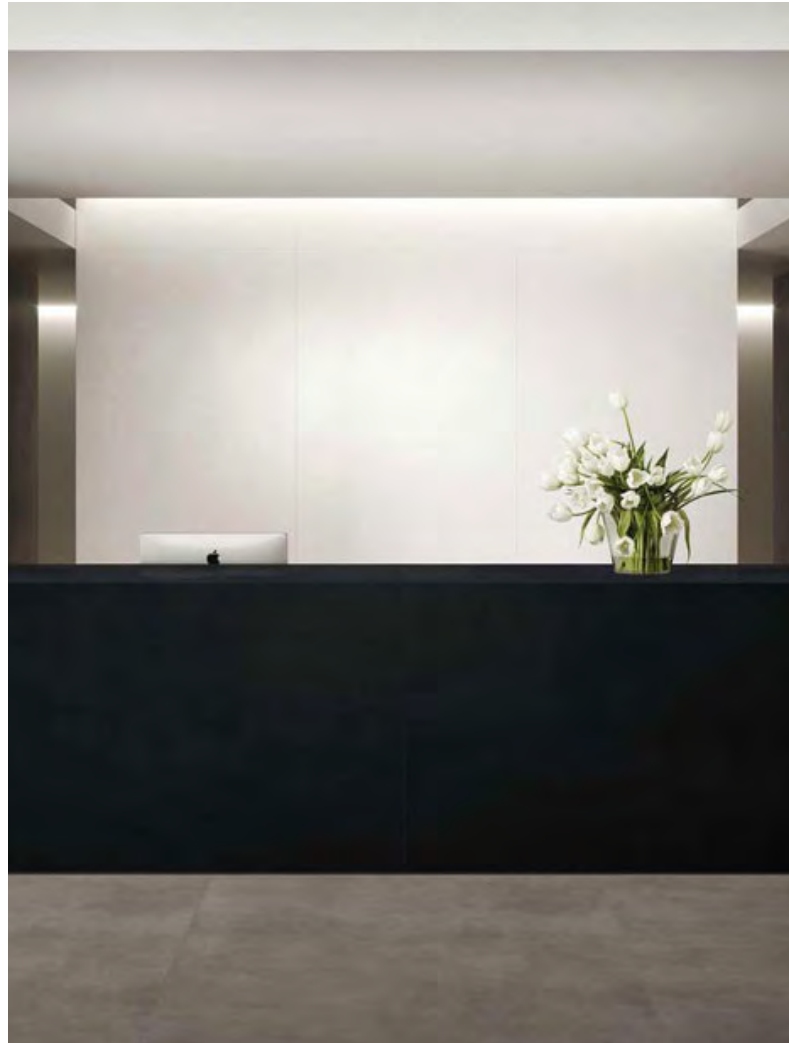
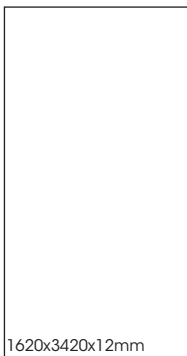

SOLID BLACK



# Grande Max

## PRODUCT SPECIFICATIONS

SIZES	FINISHES	TILE EDGE
1200x1200x6mm*	MATT	RECTIFIED
1200x2400x6mm*	MATT	RECTIFIED
1600x3200x6mm*	MATT	RECTIFIED
1620x3240x12mm*	MATT	-

\* Indent item - Subject to stock availability overseas, please allow 10-12 weeks lead time from date of order confirmation. Minimum quantity may apply.

## FORMATS

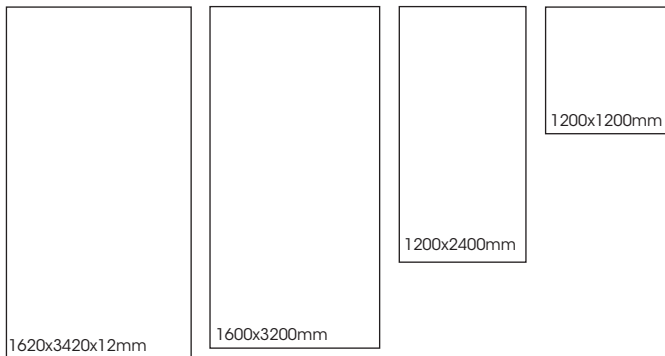

METAL IRON DARK

## METAL IRON DARK SLAB VARIATION

1620x3420x12mm



1600x3200x6mm

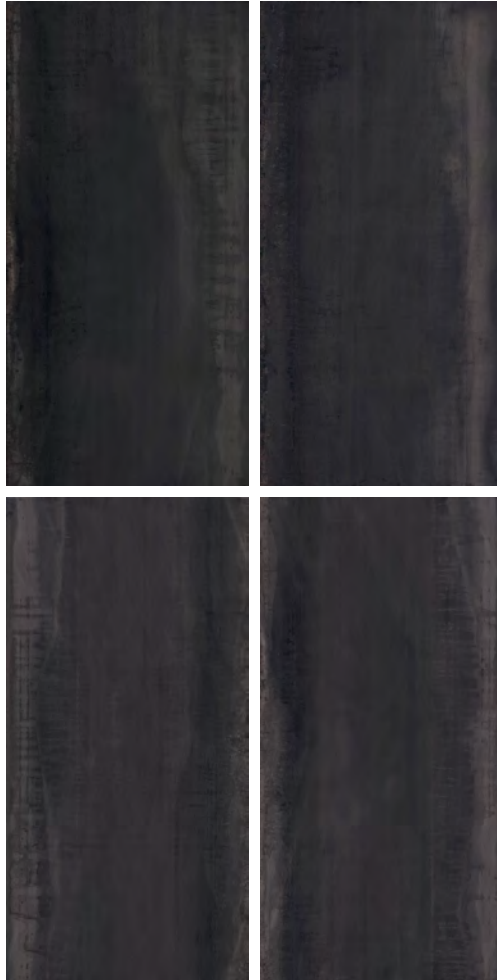

1200x2400x6mm

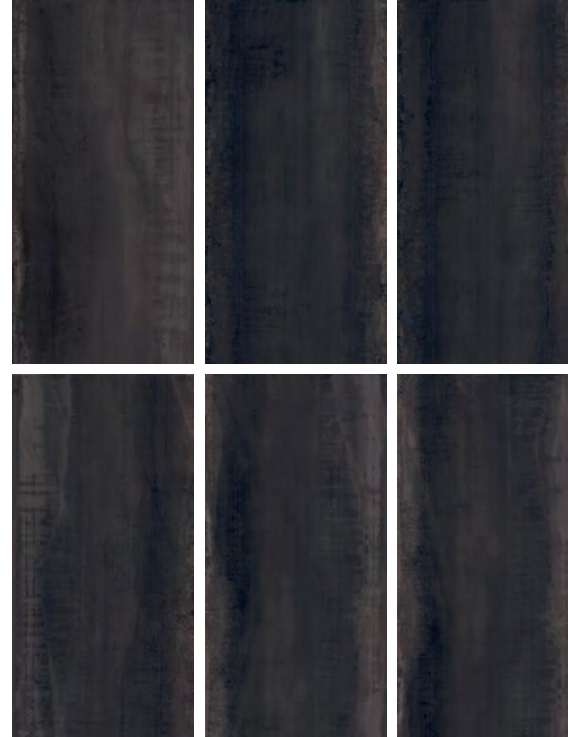

1200x1200x6mm

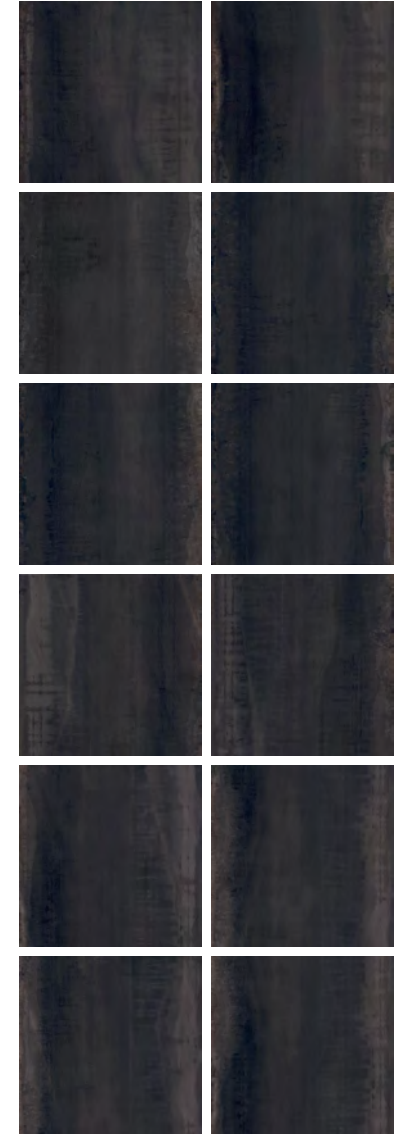

# Grande Max

# Grande Max

## PRODUCT SPECIFICATIONS

SIZES	FINISHES	TILE EDGE
1200x1200x6mm*	MATT	RECTIFIED
1200x2400x6mm*	MATT	RECTIFIED
1600x3200x6mm*	MATT	RECTIFIED
1620x3240x12mm*	MATT	-

\* Indent item - Subject to stock availability overseas, please allow 10-12 weeks lead time from date of order confirmation. Minimum quantity may apply.

## FORMATS

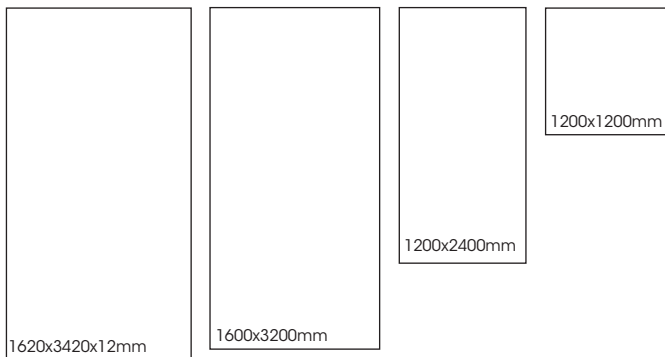

METAL IRON LIGHT

## METAL IRON LIGHT SLAB VARIATION

1620x3420x12mm



1600x3200x6mm



1200x2400x6mm



1200x1200x6mm

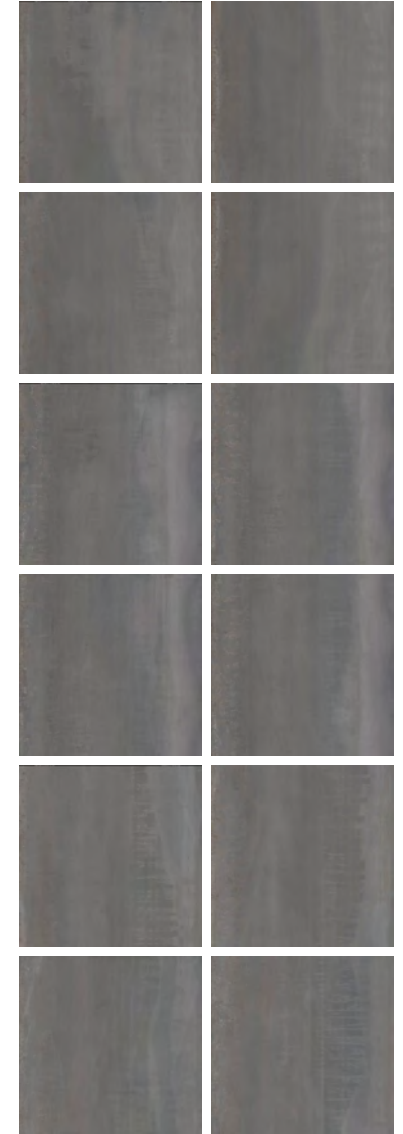









# Grande Max

GRANDE MAX 12MM COMPARISON WITH OTHER MATERIALS

# Grande Max

	GRANDE MAX	GRANDE MAX POLISH	QUARTZ	LAMINATE WOODS	SOLID SURFACES	NATURAL STONES	STEEL
HYGIENIC	●●●	●●●	●●●	●	●●●	●	●●●
NON POROUS	●●●	●●●	●●●	●	●●●	●	●●●
SUITABLE FOR USE OUTDOORS	●●●	●●●	●	●	●●	●●	●●
RESISTANT TO HIGH TEMPERATURES	●●●	●●●	●●	●	●	●●	●●●
RESISTANT TO STAINING	●●●	●●	●●	●●	●●	●	●●●
RESISTANT TO DETERGENTS	●●●	●●	●●	●●	●	●	●
RESISTANCE TO CHEMICALS	●●●	●●	●●	●	●●	●	●●
RESISTANCE TO THERMAL SHOCK	●●●	●●●	●●	●	●●	●●●	●●●
RESISTANCE TO FREEZING-DEFROSTING	●●●	●●●	●●●	●	●	●●	●●●
RESISTANT TO HUMIDITY	●●●	●●●	●●●	●	●●●	●	●●●
RESISTANCE TO UV RAYS	●●●	●●●	●●	●	●	●●	●●●
RESISTANT TO SCRATCHING AND ABRASION	●●●	●●	●●	●	●	●●	●
EASY TO CLEAN AND MAINTAIN	●●●	●●●	●●●	●●	●●	●	●

# Grande Max

	technical characteristics	test method	required values	result
	water absorption	ISO 10545-3	≤0.5%	≤0.5%
	modulus of rupture	ISO 10545-4	≥35	R≥35
	thermal shock resistance	ISO 10545-9	Pass	Pass
	breaking strength	ISO 10545-4	≥700	≥1300
	abrasion resistance	ISO 10545-7	Concrete Metal Solid   Class H Marble Stone Satin   Class G Marble Solid Lux   Class F	Class H Class G Class F
	deep abrasion resistance	ISO 10545-6	120-150mm	≤175
	chemical resistance	ISO 10545-13	Pass	Pass
	stain resistance	ISO 10545-14	Class 5	Class 3
	resistance to frost	ISO 10545-12	Pass	Pass